

# ARCAM

## FMJ A28

HANDBOOK Integrated amplifier

MANUEL Amplificateur intégré

HANDBUCH Integrierter Verstärker

HANDLEIDING Geïntegreerde versterker

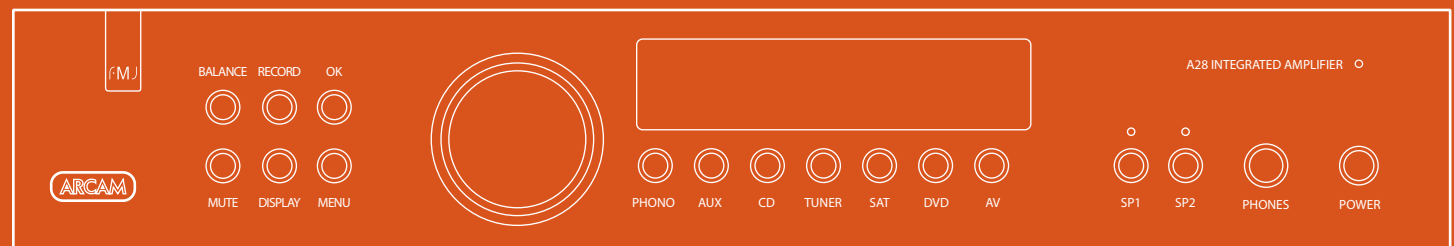

# safety guidelines





**CAUTION**  
RISK OF ELECTRIC SHOCK DO NOT OPEN



**ATTENTION**  
RISQUE DE CHOC ELECTRIQUE NE PAS OUVRIR

**CAUTION:** To reduce the risk of electric shock, do not remove cover (or back). No user serviceable parts inside. Refer servicing to qualified service personnel.

**WARNING:** To reduce the risk of fire or electric shock, do not expose this apparatus to rain or moisture.

The lightning flash with an arrowhead symbol within an equilateral triangle, is intended to alert the user to the presence of uninsulated 'dangerous voltage' within the product's enclosure that may be of sufficient magnitude to constitute a risk of electric shock to persons.

The exclamation point within an equilateral triangle is intended to alert the user to the presence of important operating and maintenance (servicing) instructions in the literature accompanying the product.

**CAUTION:** In Canada and the USA, to prevent electric shock, match the wide blade of the plug to the wide slot in the socket and insert the plug fully into the socket.

## Class I product

This equipment is a Class I electrical appliance. It requires safety connection to electrical earth ('ground' in the U.S.).

Many of these items are common sense precautions but, for your own safety and to ensure that you do not damage the unit, we recommend that you read them.

## Important safety instructions

This product is designed and manufactured to meet strict quality and safety standards. However, you should be aware of the following installation and operation precautions.

### 1. Take heed of warnings and instructions

You should read all the safety and operating instructions before operating this equipment. Retain this handbook for future reference and adhere to all warnings in the handbook or on the equipment.

### 2. Water and moisture

The presence of electricity near water can be dangerous. Do not use the equipment near water – for example next to a bathtub, washbowl, kitchen sink, in a wet basement or near a swimming pool, etc.

### 3. Object or liquid entry

Take care that objects do not fall and liquids are not spilled into the enclosure through any openings. Liquid-filled objects such as vases should not be placed on the equipment.

### 4. Placing the equipment

Only use a rack or shelf that is stable and strong enough to support the weight of this equipment.

### 5. Ventilation

Do not place the equipment on a bed, sofa, rug or similar soft surface, or in an enclosed bookcase or cabinet, since ventilation may be impeded.

### 5. Heat

Locate the equipment away from naked flames or heat-producing appliances such as radiators, stoves or other appliances that produce heat.

### 6. Climate

The equipment has been designed for use in moderate climates and in domestic situations.

### 8. Cleaning

Unplug the unit from the mains supply before cleaning.

The case should normally only require a wipe with a soft, lint-free cloth. Do not use chemical solvents for cleaning.

We do not advise the use of furniture cleaning sprays or polishes as they can cause permanent white marks.

### 9. Power sources

Only connect the equipment to a power supply of the type described in the operating instructions or as marked on the equipment.

The primary method of isolating the equipment from the mains supply is to remove the mains plug. The equipment must be installed in a manner that makes disconnection possible.

### 10. Power-cord protection

Power supply cords should be routed so that they are not likely to be walked on or pinched by items placed upon or against them. Pay particular attention to the point where they exit from the equipment.

### 11. Non-use periods

If the equipment is not being used for an extended period, we recommend that you unplug the power cord of the equipment from the wall outlet, to save power.

### 12. Abnormal smell

If an abnormal smell or smoke is detected from the equipment, turn the power off immediately and unplug the equipment from the wall outlet. Contact your dealer and do not reconnect the equipment.

### 13. Servicing

You should not attempt to service the equipment. Contact your dealer to arrange servicing.

### 14. Damage requiring service

The equipment should be serviced by qualified service personnel when:

- A. the power-supply cord or the plug has been damaged, or
- B. objects have fallen, or liquid has spilled into the equipment, or
- C. the equipment has been exposed to rain, or
- D. the equipment does not appear to operate normally or exhibits a marked change in performance, or
- E. the equipment has been dropped or the enclosure damaged.

## Safety compliance

This equipment has been designed to meet the IEC/EN 60065 international electrical safety standard.

This device complies with Part 15 of the FCC Rules. Operation is subject to the following two conditions: (1) This device may not cause harmful interference, and (2) this device must accept any interference received, including interference that may cause undesired operation.

## Contents

<b>safety guidelines</b> .....	<b>E-2</b>
Important safety instructions.....	E-2
Safety compliance.....	E-2
<b>welcome</b> .....	<b>E-3</b>
<b>overview</b> .....	<b>E-4</b>
Placing the unit .....	E-5
Power .....	E-5
Interconnect cables.....	E-5
<b>A28 connections</b> .....	<b>E-6</b>
Pre-/power-amplifier connections.....	E-7
Recording loop.....	E-7
Audio inputs.....	E-7
Phono input.....	E-7
Controlling the A28 from a second room .....	E-7
<b>loudspeakers</b> .....	<b>E-8</b>
Connecting loudspeakers to the A28 .....	E-8
Single wiring .....	E-9
Bi-wiring.....	E-9
Bi-amping.....	E-9
Switching the A28 on.....	E-10
Changing the volume.....	E-10
Selecting an audio source .....	E-10
<b>operation</b> .....	<b>E-10</b>
Recording an audio source .....	E-10
<b>A28 setup</b> .....	<b>E-11</b>
Configuring your A28 amplifier.....	E-11
<b>remote control</b> .....	<b>E-12</b>
The CR90 Universal remote controller.....	E-12
Source keys .....	E-12
Amp commands .....	E-13
<b>specifications</b> .....	<b>E-14</b>
Troubleshooting .....	E-15
Remote-control codes .....	E-15
<b>product guarantee</b> .....	<b>E-16</b>

*Thank you and congratulations for purchasing your Arcam FMJ Amplifier.*

*Arcam has been producing specialist audio products of remarkable quality for over three decades and the new A28 amplifier is the latest in a long line of award winning HiFi. The design of the FMJ range draws upon all of Arcam's experience as one of the UK's most respected audio companies, to produce Arcam's best performing range of stereo amplifiers yet – designed and built to give you years of listening enjoyment.*

*This handbook is intended to give you a detailed guide to using the A28 Integrated Amplifier . It starts by giving advice on installation, moves on to describe how to use the product and finishes with additional information on the more advanced features. Use the contents list shown on this page to guide you to the section of interest.*

*We hope that your FMJ amplifier will give you years of trouble-free operation. In the unlikely event of any fault, or if you simply require further information about Arcam products, our network of dealers will be happy to help you. Further information can also be found on the Arcam website at [www.arcam.co.uk](http://www.arcam.co.uk).*

**The FMJ development team**

welcome

English

## overview

Arcam's A28 Integrated Amplifier provides class-leading sound quality.

The A28 features a number of new technologies which practically eliminate thermal modulation of audio signals and ensures a truly dynamic and thrilling reproduction. New output devices and dramatically improved thermal coupling results in improved linearity.

A toroidal power supply delivers effortless power with low noise. A new volume control gives unprecedented linearity and noise performance, allowing fine details to be reproduced in startling clarity.

The CR90 remote control supplied with the A28 is an eight-page 'universal' learning remote control which is simple to use, and once set up is able to control a complete system. It can be programmed using its vast internal code library to control CD players, tuners, TVs and other devices.

**The A28 Integrated Amplifier is designed to produce a level of performance that will truly bring music and movies to life.**

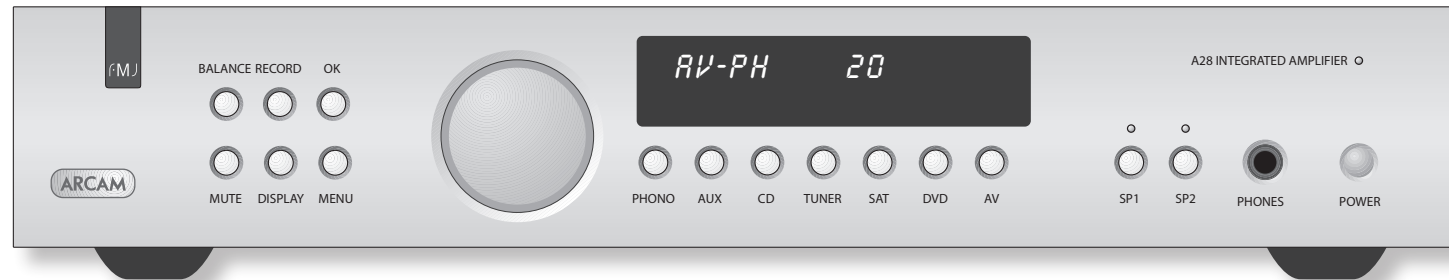

## Placing the unit

- Place the amplifier on a level, firm surface, avoiding direct sunlight and sources of heat or damp.
- Do not place the A28 on top of a power amplifier or other source of heat.
- Do not place the amplifier in an enclosed space such as a bookcase or closed cabinet unless there is good provision for ventilation. The A28 is designed to run warm during normal operation.
- Do not place any other component or item on top of the amplifier as this may obstruct airflow around the heat-sink, causing the amplifier to run hot. (The unit placed on top of the amplifier would become hot, too.)
- Make sure the remote-control receiver to the right of the front panel display is unobstructed, otherwise this will impair the use of the remote-control. If line-of-sight is impractical, a remote-control repeater can be used with the rear panel connector (see page 7).
- Do not place your record deck on top of this unit. Record decks are very sensitive to the noise generated by mains power supplies which will be heard as a background 'hum' if the record deck is too close.

## Power

The amplifier is supplied with a moulded mains plug already fitted to the lead. Check that the plug supplied fits your supply – should you require a new mains lead, please contact your Arcam dealer.

If your mains supply voltage or mains plug is different, please contact your Arcam dealer immediately

Push the IEC plug end of the power cable into the socket on the back of the amplifier, making sure that it is pushed in firmly. Plug the other end of the cable into your mains socket and, if necessary, switch the socket on.

### Stand-by power

For remote stand-by operation, the amplifier's control power-supply is powered on any time the unit is connected to the mains supply. The front-panel power-switch powers all other circuitry down and power consumption in this mode is less than 2W.

This means that even though the power-switch is off, it may be possible to hear a slight residual hum coming from the mains transformer inside the amplifier. This is perfectly normal. However, if the unit is to be left unused for an extended period, we recommend that you disconnect it from the mains supply.

## Interconnect cables

We recommend the use of high-quality screened cables that are designed for the particular application. Other cables will have different impedance characteristics that will degrade the performance of your system (for example, do not use cabling intended for video use to carry audio signals). All cables should be kept as short as is practically possible.

It is good practice when connecting your equipment to make sure that the mains power-supply cabling is kept as far away as possible from your audio cables. Failure to do so may result in unwanted noise in the audio signals.

# A28 connections

**NOTE**  
The TRIG OUT and REMOTE IN functions are only used in multi-room systems. They are not required for normal use.

**Power inlet**  
Connect the correct mains cable here.

**Voltage select**  
Ensure the voltage selected matches your local power supply.

**Trig out**  
This output provides a 12V signal whenever the unit is switched on (i.e., not 'off' or in 'stand-by'). This signal can be used to switch on power amplifiers (or other equipment) connected to the A28.

**Speaker terminals**  
The A28 is equipped with two sets of speaker terminals. See page 8 for information on connecting loudspeakers.

**Remote in**  
This allows remote-control signals to be received by the A28 if the remote sensor is covered (or otherwise not 'visible' to the remote-control). See page 7 for more information.

**Pre-/power-amplifier connections**  
These sockets are only used if you are using the A28 as a pre-amp, for example, when using the A28 in conjunction with a P38 in a bi-amplified system. See page 9 for more information.

**NOTE**  
Please read the 'Placing the unit', 'Power' and 'Interconnect cables' sections on page 5 before connecting up your A28 integrated amplifier!

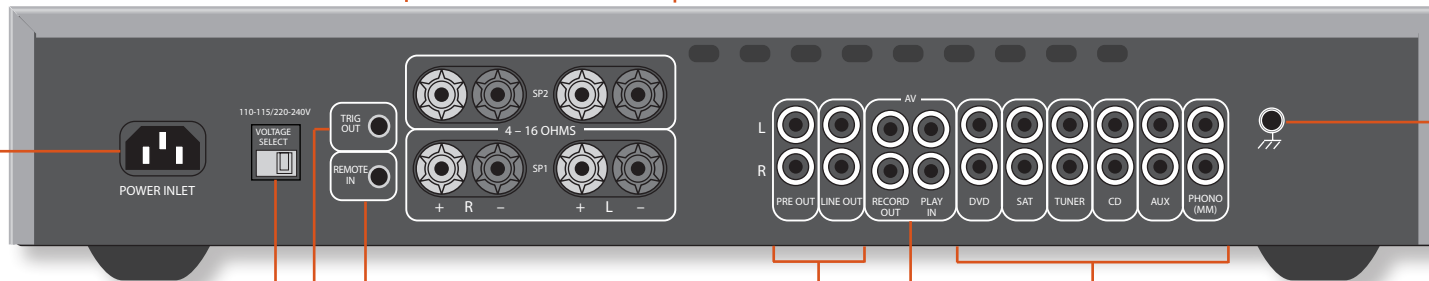

**Phono earth terminal**  
For connecting your turntable earth lead (if required). Note that this terminal must not be used as a safety earth.

**Audio inputs**  
The labels below the inputs give suggested audio inputs, although any suitable device may be connected to the line-level inputs. (Note, however, that the name of the input shown on the front-panel display cannot be changed.)  
DVD, SAT, TUNER, CD and AUX are all line-level inputs. The PHONO (MM) input has different characteristics – see page 14 for the specification. See page 7 for more information.

**Recording loop**  
The A28 is equipped with a recording loop for use with recording devices (CD recorders, cassette decks, etc.). See pages 7 and 10 for more information.

## Pre-/power-amplifier connections

### PRE OUT

To use your A28 as a dedicated pre-amplifier, or as part of a bi-amp'd system, connect the **PRE OUT** sockets to the input sockets of your power amplifier.

## Recording loop

The A28 is equipped with a recording loop, for use with recording devices (such as a CD recorder, DAT recorder, cassette recorder, VCR, PVR etc.).

### AV RECORD OUT

Connect these output sockets to the input sockets of your recording device (usually labelled **RECORD** or **IN**).

### AV PLAY IN

Connect the output sockets of your recording device (usually labelled **PLAY** or **OUT**) to these inputs.

If you do not have a recording device, you can use this input for other (line-level) equipment, such as a TV, DVD, CD player, radio tuner, PVR, etc.

## Audio inputs

Although the inputs are labelled for specific devices, all have the same characteristics and each may be used with any line-level product. The exception is the Phono input (see page 14 for the specification).

### DVD

Intended for the analogue outputs from a DVD-player.

### AV

Intended for the analogue outputs from general audio-visual equipment, such as a VCR, digital TV/satellite receiver, or Nicam tuner.

### TUNER

Intended for the analogue outputs from an FM, AM or DAB radio tuner.

### CD

Intended for the analogue outputs from a CD player.

### AUX

This is intended for general use, or for connecting an iPod® via an Arcam **rLead** or **rDock**. However, it can also be used to connect the analogue audio outputs of any unit with a line-level output (such as a games console or set-top box).

### SAT

For connection to a satellite TV receiver or cable box.

## Phono input

The phono inputs provide a pre-amplification stage to treat the low-voltage output from a moving magnet cartridge. If you have already an external phono amplifier that you wish to use, connect its output to one of the line-level inputs, such as the **AUX** input.

## Controlling the A28 from a second room

The A28 will require a remote pick-up device with a 12V external power supply (such as a Xantech Dinky Link) located in Zone 2, together with a power amplifier (such as an Arcam A28 or P38) to complete the system.

The diagram shows the wiring scheme, which also applies to other IR pick-up devices commonly available.

The A28 can also provide a +12V trigger output to control devices such as the power amplifier in Zone 2. The +12V trigger is active when the unit is 'On'.

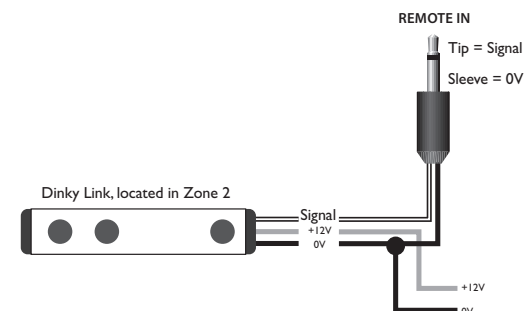

# loudspeakers

## Connecting loudspeakers to the A28

### Single wiring

Single wiring is the conventional wiring method of running a single cable per channel between the amplifier and the speaker; this is the easiest technique.

### Bi-wiring

Bi-wiring is running two separate cables between the amplifier and each speaker, with one cable carrying the low-frequency information, the other the higher-frequency signals.

Bi-wiring can improve the sound of your system because the separation of high- and low-frequency signal currents into different speaker cables avoids distortions caused by the different currents interacting with one-another within a single cable.

The A28 is designed to allow easy bi-wiring, but your loudspeakers need to provide separate terminals for the two cables. Each speaker must have two pairs of terminals; one pair labelled HF or 'High Frequency', the other pair labelled LF or 'Low Frequency'.

### Bi-amping

Bi-amping is the separation of the amplification of low- and high-frequency signals over two amplifiers.

Bi-amping requires the use of two amplifiers per channel. Normally, your A28 is used to drive the high-frequency (treble) speakers, with a P38 used for the lower (bass) frequencies.

### Notes on making speaker connections

- Do not make any connections to any amplifier while it is switched on. We recommend that your amplifier is completely disconnected from the mains supply before starting.
- Before switching your amplifier(s) on for the first time after connecting to speakers, please check all connections thoroughly. Ensure that bare wires or cables are not touching each other or the amplifier's chassis (which could cause short circuits), and that you have connected positive (+) to positive and negative (-) to negative. Be sure to check the wiring for both the amplifier **and** the speaker.
- After making connections: switch the amplifier(s) on, select a source signal, then gradually increase the volume to the required listening level.
- If you are unsure as to how your system should be connected, or need advice on bi-wiring or bi-amping, please contact your Arcam dealer who will be happy to help you.



## Single wiring

The A28 is designed for bi-wiring, which is why there are duplicate speaker terminals on the back. For single wiring, we recommend that you use the lower set of speaker terminals on your amplifier. If each speaker has more than one pair of connecting terminals, use the terminals labelled **LF** or 'Low Frequency' for each speaker.

Connect the positive terminal of the right speaker connection on the amplifier (coloured red and labelled **+R**) to the positive terminal of your right speaker. Similarly, connect the negative terminal of the amplifier (coloured black and labelled with **R-**) to the negative terminal of your speaker. Repeat the process for the left speaker, using the amplifier terminals labelled **+L** and **L-**.

If your speakers support bi-wiring, then there is a strip of conductive metal on the speakers connecting the low-frequency terminals to those for the higher-frequencies; this **MUST NOT BE REMOVED** in a single-wired system.

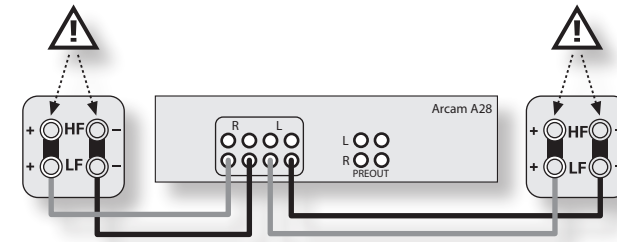

An A28 connected to speakers using single wiring

## Bi-wiring

Bi-wiring is performed in the same way as single wiring except that, for each speaker, a **pair** of cables are used to connect the amplifier to each speaker.

Follow the instructions given for single wiring; then perform the same actions, this time connecting the upper set of speaker terminals on your amplifier to the terminals labelled **HF** or 'High Frequency' for each speaker. Please refer to the illustration.

Speakers that support bi-wiring have a strip of metal on the speakers connecting the low-frequency terminals to those for the higher-frequencies; this **MUST BE REMOVED** in a bi-wired system.

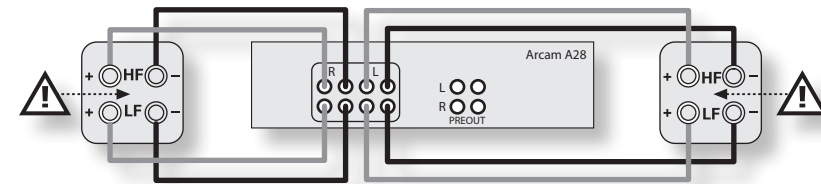

An A28 connected to speakers using bi-wiring

## Bi-amping

Bi-amping requires the use of two amplifiers per channel. Normally, your A28 is used to drive the high-frequency (treble) speakers, while a power-amplifier (such as a P38) is used for the lower (bass) frequencies.

Connect your A28 to the speakers as described for single wiring, with the exception that the A28 should be connected to the speaker terminals labelled **HF** or 'High Frequency'. Then connect the power amplifier (P38, for example) to the **LF** or 'Low Frequency' terminals, as in the diagram. A pair of audio interconnect cables are also required to connect the pre-amp outputs of the A28 to the power amp inputs of the P38.

Note that the strip of metal on the speakers connecting the lower terminals to the upper terminals **MUST BE REMOVED**. Failure to do so will result in damage to both amplifiers, which will not normally be covered under warranty.

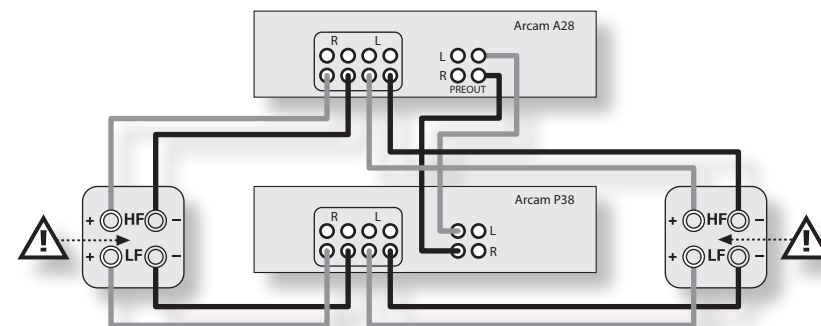

An A28 and P38 connected to speakers using bi-amping

## operation

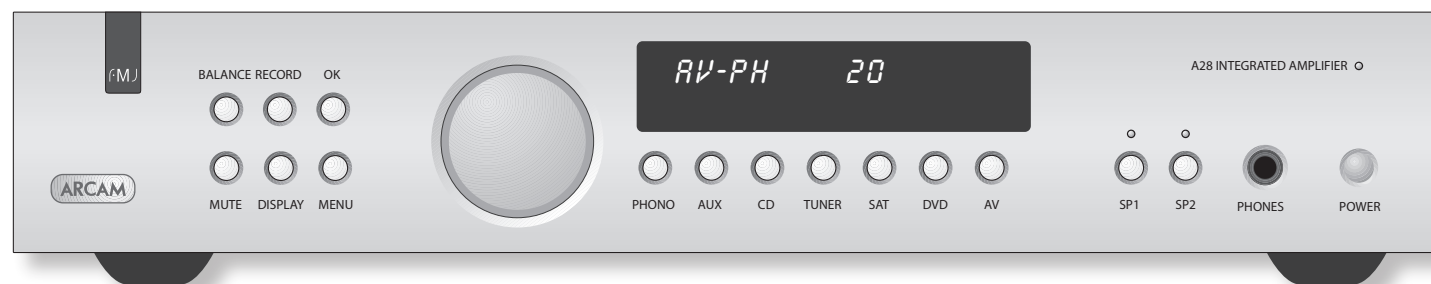

### Switching the A28 on

The **POWER** button switches the unit on and off; alternatively, the unit can be switched in and out of stand-by mode by pressing the  button on the remote control handset.

The power light (next to the 'A28 Integrated Amplifier' text) indicates the state of the amplifier:

1. A red light means that the amplifier is in stand-by mode;
2. When you switch your amplifier on, the power light glows amber for a few seconds; during this time the outputs are muted;
3. The light changes to green when the amplifier is ready for use.

The power light may flash if a fault has occurred – the fault type is shown on the display. See page 15, 'Troubleshooting', for help in resolving fault situations. If the fault cannot be cleared, unplug your amplifier and contact your Arcam dealer.

### Changing the volume

Use the control knob to change the volume. Turn the knob clockwise to increase the volume, anti-clockwise to reduce it.

The output of the A28 can be silenced by pressing **MUTE** on the front panel or remote control. Press **MUTE** for a second time (or change the volume) to cancel the mute.

#### SP1 and SP2

These buttons allow you to switch the main speakers (connected to the lower set of speaker terminals) and secondary speakers (connected to the upper set of speaker terminals) on and off.

The light above each button glows if the corresponding speakers are currently selected. If you have connected the A28 to the speakers using the single-wired configuration described on page 9, then the **SP1** light should be illuminated; if you have used the bi-wiring configuration described on page 9, both **SP1** and **SP2** must be switched on. Note that when both lights are off, the amplifier will appear not to work, as all speakers are disconnected.

When listening to 'loud' inputs, such as CDs, the amplifier may reach its full power before the display shows **72** (maximum volume), in contrast, lower-level inputs, such as tuners, will sound quieter for the same volume level shown. To compensate for this, the input levels of each source may be adjusted. This can be done using the A28 setup menu (see page 11).

### Selecting an audio source

A source-selection button is used to select the source that is connected to the input corresponding to the button.

#### Listening using headphones

The headphones socket (**PHONES**) accepts headphones with an impedance rating between 8Ω and 2kΩ, fitted with a 6.5mm stereo jack plug.

The pre-amp. outputs and speakers are muted when headphones are plugged in. The headphones socket is always active, unless the volume has been muted.

#### Balance

In addition to the A28 setup menu (see page 11), you can also set left-right stereo balance directly by pressing the front-panel **BALANCE** button and adjusting the balance with the control knob.

#### Display

The **DISPLAY** front panel button changes the display brightness. There are three brightness levels: 'on', 'dimmed' and 'off'. If the A28 is switched off while the display is set to 'off', the display is set to 'dimmed' when the A28 is switched on again.

### Recording an audio source

The A28 allows listening to and recording from the same source, or listening to one source whilst recording another. The signal to be recorded is sent to both the **AV** and **AUX** output sockets.

#### Selecting the source for recording

The recording outputs can be configured in two ways:

1. To record the source being listened to;
2. To record a particular (specified) source, regardless of what is being listened to.

**To record the source being listened to**, press the **RECORD** button and turn the control knob if necessary until the display shows '**REC SRC**'. After a few seconds, the display reverts to showing the volume level, and you are ready to record. In this configuration, selecting a different input changes the source that is routed to the recording outputs.

**To record one source whilst listening to another**, press **RECORD** and turn the control knob until the display shows '**REC**' followed by the name of the input (**SAT**, **PHONO**, **CD**, **TUNER**, **AUX** or **DVD**) that you wish to record from. You are now ready to record.

Press a different source button to change the source that you wish to listen to – this does not alter the source that is routed to the recording outputs.

# A28 setup

## Configuring your A28 amplifier

### Adjusting listening settings

The A28 allows you to customise various features of the amplifier to fit your system. Use this diagram to help you navigate through the available configuration options.

In the diagram, the control knob is shown as .

Normally, the display shows the source and the current volume.

Press **MENU** once to enter the setup menu, use the control knob to cycle through the menu items. When

you have found the setting that you wish to adjust (as shown on the front panel display), press **OK**. To adjust the chosen setting, use the control knob. Press **MENU** to store the change and return to volume display mode – or press **OK** again to move to the next setting.

Note that the menu will time-out after a short period without pressing a button or adjusting the control knob, with the display reverting to the current volume.

The following items can be adjusted from the setup menu:

<i>BALANCE</i>	This allows you to adjust the output balance between left and right channels. The balance control is also available directly by pressing the front panel <b>BALANCE</b> button.
<i>VOL RES</i>	There are three volume-display options to choose from: ' <i>STD</i> ', ' <i>FINE</i> ' or ' <i>REF</i> '. Standard and Fine represent different levels of volume-control sensitivity; the Reference setting gives absolute increments in 0.5dB steps.
<i>I/P TRIMS</i>	Input trims are used to compensate for variations in output levels of different source equipment. If, for example, your CD player is louder at a given volume display value than other inputs, you can attenuate it by using this setting so that it matches your other components. Use the source-select buttons to select the input you wish to adjust, then the control knob to set (increase or decrease) the input volume for that source.
<i>PROC MODE</i>	Processor mode enables you to fix the gain (volume setting) of your A28. The A28 (in combination with a power amp.) can then be used to drive the front left and right speakers of a surround-sound system, when fed from a separate processor. The volume of the entire system can then be controlled using the processor. Feed the sound from the processor into the <b>AV</b> input, then set the gain of the A28 to match the amplifiers that drive your other loudspeakers.
<i>REC SRC</i>	To record one source while listening to another, turn the control knob until the display shows ' <i>REC</i> ' followed by the name of the input ( <i>SAT</i> , <i>PHONO</i> , <i>CD</i> , <i>TUNER</i> , <i>AUX</i> or <i>DVD</i> ) that you wish to record from. The record source control is also available directly by pressing the front panel <b>RECORD</b> button.
<i>MAX ONVOL</i>	This can be used to limit the maximum volume the amplifier operates at when it is first switched on: the A28 comes on at the (reduced) 'Max. On Volume' level if the last-used volume exceeds this value. If this item is set to ' <i>OFF</i> ', the A28 always comes on at the last used volume, even if this is very loud.
<i>RESET</i>	Confirming ' <i>YES</i> ' restores all amplifier settings to their factory defaults.

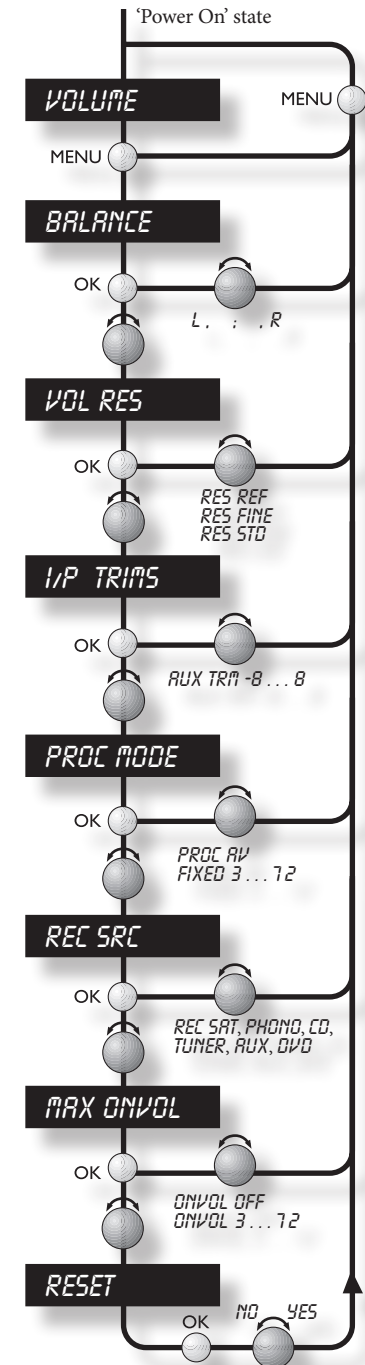

# remote control

## The CR90 Universal remote controller

The CR90 is a sophisticated 'universal' remote control that can control up to eight devices. It's pre-programmed for use with the A28 and many other Arcam products (FM/DAB tuners, CD players and DVD players).

With its extensive built-in library of codes, it can also be used with thousands of other audio-visual components – TVs, satellite and set-top boxes, PVRs and third-party CD players. See the final section of the CR90 Handbook for a list of these.

The CR90 is a 'learning' remote, so you can teach it almost any function from an old single-device remote. You can also program the CR90 to issue a sequence of commands ('macros') from a single button press – see the CR90 Handbook for details.

As the CR90 is a system remote controller, some of the keys are not used with the A28. For instance, the PVR and CD keys can still be programmed to control products, so if you have a PVR connected directly to your TV or SAT box, you can use the CR90 to control it as part of your system.

## Source keys

As the CR90 can control your A28 as well as a range of other equipment, many of the buttons have more than one function depending on the 'device mode' or 'page' selected.

The device selection keys: **DVD**, **SAT**, **AV (TV)**, **TUN**, **AMP** and **AUX**, both select the source and configure the CR90 to control the particular source.

In other words, the buttons are often 'context sensitive' so you'll have to tell it what sort of device you wish to control (press the **AV** button for a video display, for example) before you can control it.

### Select the source key first

Remember to select a source key **before** pressing command buttons – commands vary depending on the source selected!



DVD	DVD player
SAT	Satellite set-top box
AV	Audio-visual sound input (use with TV)
TUN	DAB, FM or AM tuner
AMP	Controls the Amplifier features of the A28 (and indirectly, of a P38 connected to the A28)
AUX	Auxiliary input, or an iPod® via an rDock or rLead
PVR	Not used on the A28
CD	Compact Disc player

## Inserting batteries into the remote control

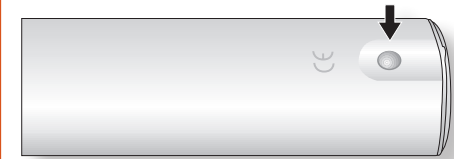

1. Open the battery compartment by pressing the button on the back of the handset.

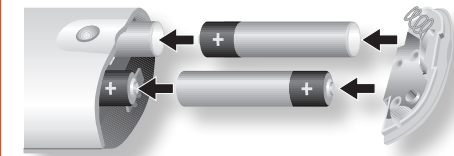

2. Insert four 'AAA' batteries into the battery compartment – two facing the top of the unit, and two facing the end, as in the diagram.
3. Lower the end cap onto the plastic locating plate in the handset. This acts as a hinge, and you can now push the end cap firmly into its locked position with a click.



## AMP **Amp commands**

	<b>POWER</b> – Switches A28 between stand-by and on
1-9	Some number keys can be used for source selection: 1 DVD input 2 CD input 3 AV-PH FX 4 AUX Auxiliary line input 5 Not used on A28 6 SAT Satellite decoder input 7 TUN DAB/FM/AM tuner input 8 Phono input 9 Not used on A28
SHIFT	Modifies many keys (see individual key descriptions, below)
	Navigate the menus on A28. <b>OK</b> confirms a selection.  <b>SHIFT</b> +  to Power on <b>SHIFT</b> +  to Power off
<b>OK</b>	Confirms a setting (equivalent to 'Enter' or 'Select' on some remote controls)
<b>MENU</b>	Displays the A28 setup menu on the front panel (see page 11)
<b>DISP</b>	Cycles through Display panel brightness options (dim to bright, off)
	Press once to mute the speaker and pre-amp outputs. Press for a second time (or change the volume) to unmute the unit.
	Decrease (-) and increase (+) amplifier volume



specifications

<b>Continuous power output (20Hz—20kHz at 0.5% THD), per channel</b>	
Both channels, 8Ω, 20Hz—20kHz	75W
Single channel, 4Ω, at 1kHz	130W
Harmonic distortion, 80% power, 8Ω at 1kHz	0.004%
<b>Inputs</b>	
Phono cartridge:	
Input sensitivity at 1kHz	2.5–15mV (user adjustable)
Input impedance	47kΩ
Signal/noise ratio (CCIR, 65W)	88dB
Overload margin	31dB
Line and AV inputs:	
Nominal sensitivity	250mV–1.5V (user adjustable)
Input impedance	22kΩ
Signal/noise ratio (CCIR, 65W)	98dB
<b>Preamplifier output</b>	
Nominal output level	630mV
Output impedance	<50Ω
<b>Headphone output</b>	
Maximum output level into 600Ω	7V
Output impedance	100Ω
<b>General</b>	
Mains voltage	110-120V or 220-240V
Power consumption (maximum)	650VA
Power consumption (standby)	2.5VA
Dimensions W x D x H (including feet)	432 x 275 x 85mm
Weight (net)	8.5kg
Weight (packed)	10.4kg
Supplied accessories	mains lead CR90 remote control 4 x AAA batteries
E&OE	
<b>NOTE:</b> All specification values are typical unless otherwise stated.	

### Continual improvement policy

Arcam has a policy of continual improvement for its products. This means that designs and specifications are subject to change without notice.

## Troubleshooting

If you are having trouble with your amplifier, check the following items.

### No sound

Check the following:

- The A28 amplifier is switched on.
- The amplifier is not muted (i.e. *MUTE* is not shown on the front-panel).
- The selected source is generating audio (e.g., if CD is selected, then the CD is playing).
- The AV input is selected on the A28 instead of the expected source. In this case, press *AV* again to de-select the AV input.
- The speaker outputs are enabled on the A28/P38, as indicated by the lights above the *SP1* and/or *SP2* buttons (as appropriate) being illuminated.

### Sound cuts-out unexpectedly

If the temperature of the internal heatsink rises above a safe level, then a thermal cut-out inside the amplifier operates to protect the unit and the protection system temporarily removes power to the speakers. The system will reset itself as the heatsink cools down.

- With two pairs of low-impedance speakers connected ( $6\Omega$  or less), overloads are more likely. Overloading the amplifier may cause it to shut down because of overheating.
- Note that, due to the high output voltage from a CD player, it is possible to drive your amplifier at full power even though the volume is not set at maximum. See page 11 to adjust the input trim of a CD player or other input device.

### Amplifier does not switch back on

Both the amplifiers detailed in this handbook have a protection mechanism which is activated if you switch the unit on immediately after turning it off. If this mechanism activates, wait 30 seconds before switching the unit on again.

## Remote-control codes

The following tables give the IR commands accepted by the A28.

Note that the A28 also responds to code 20–53 (the *PLAY* command for an Arcam CD player). The A28 switches automatically to CD input on receiving this command.

#### Power commands

Command	Decimal Code
Power toggle	16–12
Power-on	16–123
Power-off	16–124

#### Source selection commands

Command	Decimal Code
<i>SAT</i> select	16–0
<i>PHONO</i> select	16–1
<i>AV</i> select	16–2
<i>TUNER</i> select	16–3
<i>DVD</i> select	16–4
<i>CD</i> select	16–7
<i>AUX</i> select	16–8

#### Menu navigation commands

Command	Decimal Code
<i>UP</i>	16–32
<i>DOWN</i>	16–33
<i>MENU</i>	16–37
<i>OK</i>	16–87

#### Display control commands

Command	Decimal Code
Display	16–59

#### Volume control commands

Command	Decimal Code
Mute	16–13
Volume up	16–16
Volume down	16–17

#### Speaker control commands

Command	Decimal Code
Speaker 1 toggle	16–35
Speaker 2 toggle	16–39
Speaker 1 on	16–43
Speaker 1 off	16–44
Speaker 2 on	16–45
Speaker 2 off	16–46



## product guarantee

### Worldwide Guarantee

This entitles you to have the unit repaired free of charge, during the first two years after purchase, at any authorised Arcam distributor provided that it was originally purchased from an authorised Arcam dealer or distributor. The manufacturer can take no responsibility for defects arising from accident, misuse, abuse, wear and tear, neglect or through unauthorized adjustment and/or repair, neither can they accept responsibility for damage or loss occurring during transit to or from the person claiming under the guarantee.

#### The warranty covers:

Parts and labour costs for two years from the purchase date. After two years you must pay for both parts and labour costs. **The warranty does not cover transportation costs at any time.**

### Claims under guarantee

This equipment should be packed in the original packing and returned to the dealer from whom it was purchased, or failing this, directly to the Arcam distributor in the country of residence.

It should be sent carriage prepaid by a reputable carrier – **not** by post. No responsibility can be accepted for the unit whilst in transit to the dealer or distributor and customers are therefore advised to insure the unit against loss or damage whilst in transit.

For further details contact Arcam at:

Arcam Customer Support Department,  
Pembroke Avenue, Waterbeach, CAMBRIDGE, CB25 9QR, England

or via [www.arcam.co.uk](http://www.arcam.co.uk).

### Problems?

If your Arcam dealer is unable to answer any query regarding this or any other Arcam product please contact Arcam Customer Support at the above address and we will do our best to help you.

### On-line registration

You can register your product on-line at [www.arcam.co.uk](http://www.arcam.co.uk).



# ARCAM